

976nm 10W Laser Diode with H-mount Package | Window Package LD | FAC Optional
976nm~980nm High Power 10W Diode Laser | Square Beam Optional | Hermetic Package
RWSLD-980-010-H

980nm Laser Diode		10W/H-mount	
Reverse Voltage	V_r	2.0	V
Operating Temperature	T_{op}	+10 ~+30	°C
Storage Temperature	T_{stg}	-20~ +80	°C
Lead soldering temperature (10 sec.)	T_{is}	260	°C
Features: <ul style="list-style-type: none"> ● 976nm ● CW ● H-mount Package (Window Package) ● FAC Lens Optional 			
Applications: <ul style="list-style-type: none"> ● Medical Laser Treatment ● Laser Pumping ● Other 			
Specifications	RWSLD-980-010-H		
	Min	Type	Max
Center Wavelength@25°C	976nm±15nm		
Spectral Width (FWHM)	----	4.0nm	----
Output Power	----	10W	----
Emitter Area	100x1µm		
Beam Divergence (FWHM)	----	30°± x 8°//	----
Temperature Coefficient of Wavelength	----	0.3nm / °C	----
Slope Efficiency	----	1.0W/A	----
Threshold Current (Typ.)	----	0.5A	1.5A
Operating Current (Typ.)	----	10.5A	11.0A
Operating Voltage	----	1.7V	2.1V
Package Style	H-mount		
Recommended Operating Temperature	25°C		

H-mount Package View

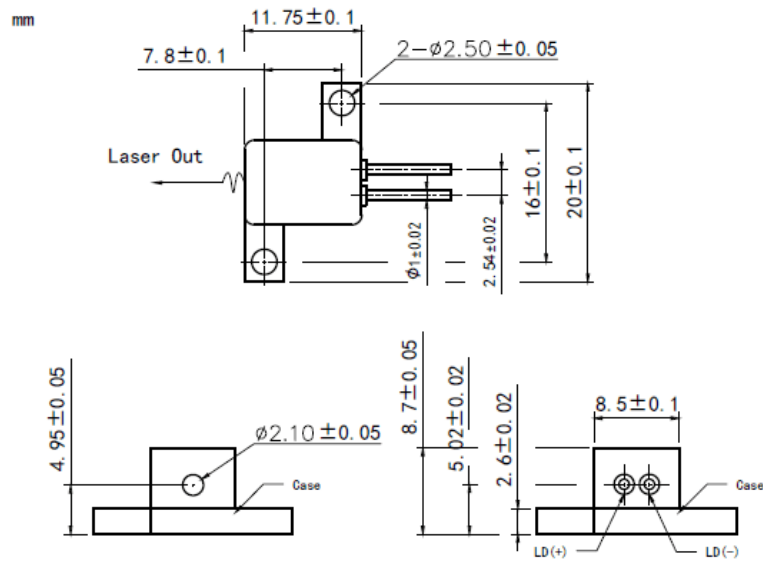

Electrically shorten LD module and store in non-extreme conditions.

Suggest using the constant current power supply.

