

1570nm 20mW DFB Laser Diodes | TO18 5.6mm LD | Flat Window Optional
1570nm 20mW Single Mode LD | With Non-Spherical Lens | Built-in Photodiode
RWLD-1570-020m-1-PD

1570nm Laser Diode 20mW Single mode /DFB			
Reverse Voltage	V_r	2.0	V
Operating Temperature	T_{op}	-10~+50	°C
Storage Temperature	T_{stg}	-40~+85	°C
Lead soldering temperature (10 sec.)	T_{is}	260	°C
Features: <ul style="list-style-type: none"> ● 1570nm ● DFB Laser ● Built-in PD ● With Non-Spherical Lens ● Flat Window Optional 			
Applications: <ul style="list-style-type: none"> ● Optical Fiber Communication ● Free-space Optical Communication 			
Specifications		RWLD-1570-020m-1-PD	
		Min	Type
Center Wavelength@25°C		$\pm 3\text{nm}$	1570nm
Spectral Width (FWHM)			0.3nm
Output Power			20mW
Recommend Operating Temperature			25°C
Laser Type			DFB
Reverse current (PD) I_{rp}			0.5mA
Reverse voltage (PD) V_{rp}			15V
Threshold Current (Typ.)			5mA
Operating Current (Typ.)			90mA
Operating Voltage			1.4V
Package Style			TO18
Window Type			Flat Window (Optional)
			Non-Spherical-Lens Window (standard)

Package View:

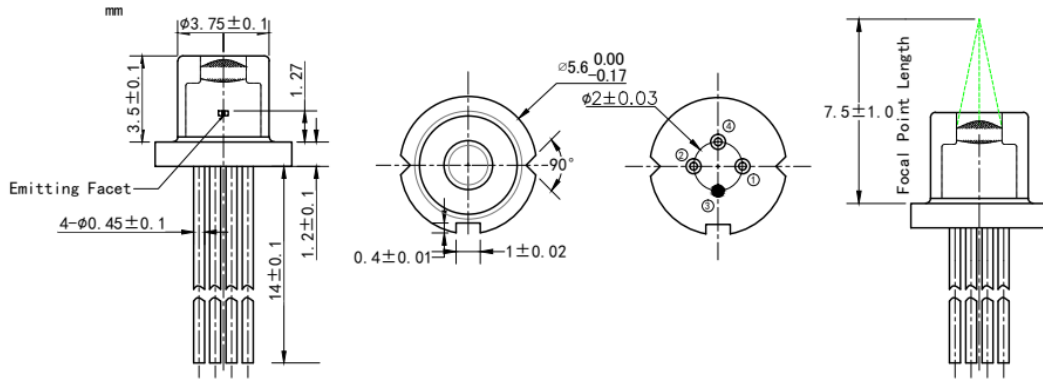

PIN Bottom View (A-Type):

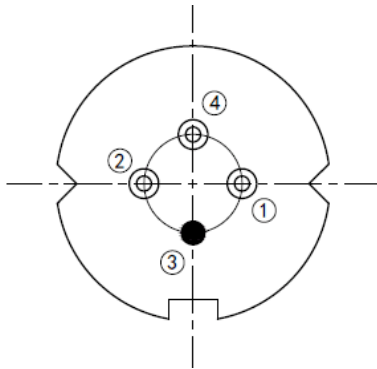

PIN 1	PD (+)
PIN 2	LD (-)
PIN 3	LD (+), CASE
PIN 4	PD (-)

PIN Bottom View (B-Type):

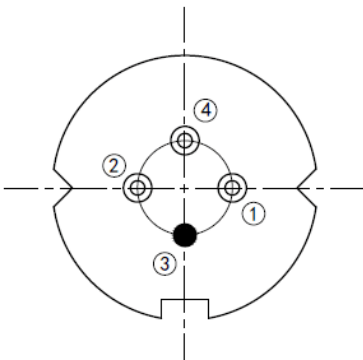

PIN 1	LD (+) PD (-)
PIN 2	LD (-)
PIN 3	CASE
PIN 4	PD (+)

Electrically shorten LD module and store in non-extreme conditions.

Suggest using the constant current power supply.

