

**1510nm 15mW DFB Laser Diodes | TO18 5.6mm LD | Flat Window Optional**  
**1510nm 15mW Single Mode LD | With Non-Spherical Lens | Built-in Photodiode**  
**RWLD-1510-015m-1-PD**

1510nm Laser Diode      15mW      Single mode /DFB			
Reverse Voltage	$V_r$	2.0	V
Operating Temperature	$T_{op}$	-10~+50	°C
Storage Temperature	$T_{stg}$	-40~+85	°C
Lead soldering temperature (10 sec.)	$T_{is}$	260	°C
<b>Features:</b> <ul style="list-style-type: none"> <li>● 1510nm</li> <li>● DFB Laser</li> <li>● Built-in PD</li> <li>● With Non-Spherical Lens</li> <li>● Flat Window Optional</li> </ul>			
<b>Applications:</b> <ul style="list-style-type: none"> <li>● Optical Fiber Communication</li> <li>● Free-space Optical Communication</li> </ul>			
<b>Specifications</b>		<b>RWLD-1510-015m-1-PD</b>	
		<b>Min</b>	<b>Type</b>
Center Wavelength@25°C		±3nm	1510nm
Spectral Width (FWHM)			0.3nm
Output Power			15mW
Recommend Operating Temperature		25°C	
Laser Type		DFB	
Reverse current (PD) $I_{rp}$			0.5mA
Reverse voltage (PD) $V_{rp}$			----
Threshold Current (Typ.)			5mA
Operating Current (Typ.)			80mA
Operating Voltage			1.4V
Package Style		TO18	
Window Type		Flat Window (Optional)	
		Non-Spherical-Lens Window (standard)	

**Package View:**

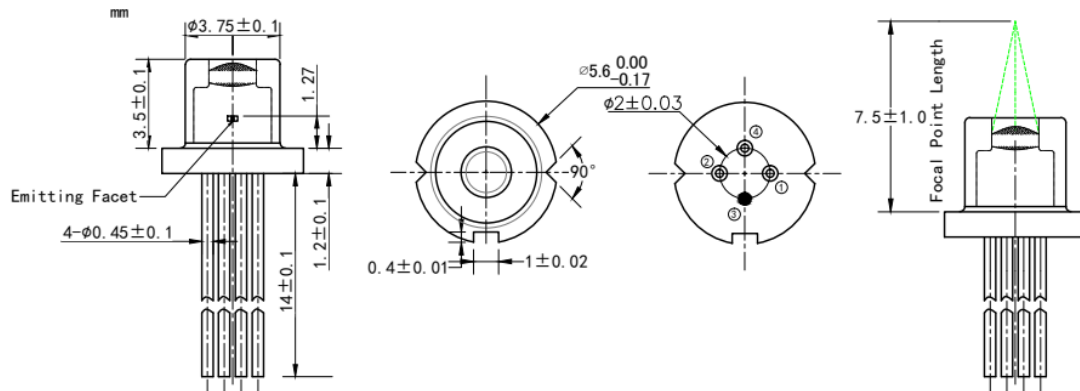

**PIN Bottom View (A-Type):**

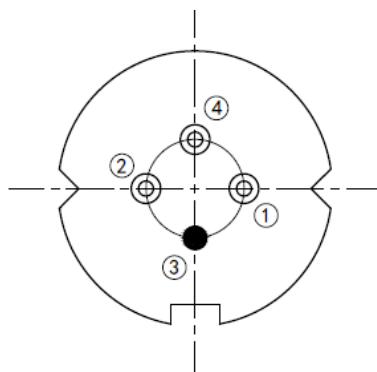

PIN 1	PD (+)
PIN 2	LD (-)
PIN 3	LD (+), CASE
PIN 4	PD (-)

**PIN Bottom View (B-Type):**

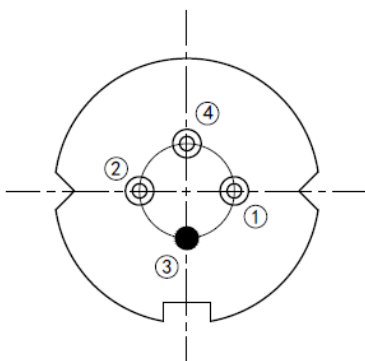

PIN 1	LD (+) PD (-)
PIN 2	LD (-)
PIN 3	CASE
PIN 4	PD (+)

**Electrically shorten LD module and store in non-extreme conditions.  
Suggest using the constant current power supply.**

