

1510nm 15mW DFB SM Laser Diodes | TO18 5.6mm LD | With Flat Window
1510nm 15mW Single Mode LD | Built-in PD
RWLD-1510-015m-1-PD-F

1510nm Laser Diode 15mW Single mode /DFB			
Reverse Voltage	V_r	2.0	V
Operating Temperature	T_{op}	-10~+50	°C
Storage Temperature	T_{stg}	-40~+85	°C
Lead soldering temperature (10 sec.)	T_{is}	260	°C
Features: <ul style="list-style-type: none"> ● 1510nm ● Single Mode Beam ● DFB LD ● With Flat Window ● Built-in PD 			
Applications: <ul style="list-style-type: none"> ● Optical Fiber Communication ● Free-space Optical Communication 			
Specifications		RWLD-1510-015m-1-PD-F	
		Min	Type
Center Wavelength@25°C		±3nm	1510nm
Output Power			15mW
Spectral Width (FWHM)			0.3nm
Laser Type			DFB
Recommend Operating Temperature			25°C
Beam Divergence (FWHM)			35° _⊥ x 25° _{//}
Reverse Current (PD) I_{rp}			0.5mA
Reverse Voltage (PD) V_{rp}			----
Threshold Current (Typ.)			5mA
Operating Current (Typ.)			90mA
Operating Voltage			1.4V
Package Style			TO18
Window Type			Flat Window

Package View:

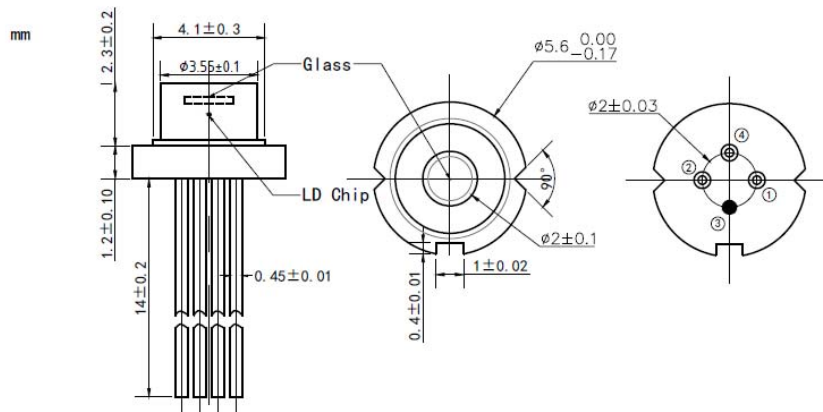

PIN Bottom View (A-Type):

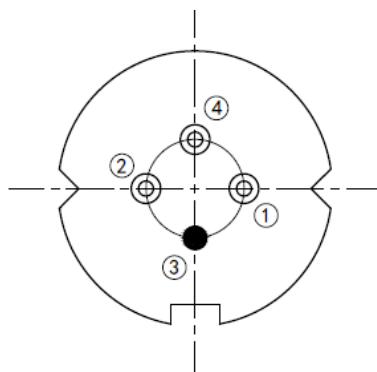

PIN 1	PD (+)
PIN 2	LD (-)
PIN 3	LD (+), CASE
PIN 4	PD (-)

PIN Bottom View (B-Type):

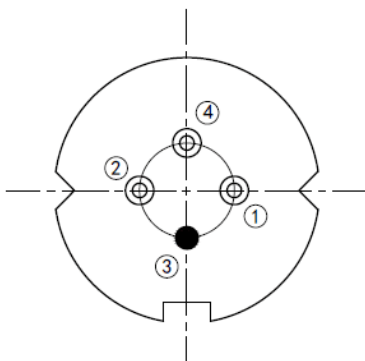

PIN 1	LD (+) PD (-)
PIN 2	LD (-)
PIN 3	CASE
PIN 4	PD (+)

Electrically shorten LD module and store in non-extreme conditions.

Suggest using the constant current power supply.

