

**1290nm 20mW DFB SM Laser Diodes | TO18 5.6mm LD | With Flat Window**  
**1290nm 20mW Single Mode LD | Built-in PD**  
**RWLD-1290-020m-1-PD-F**

1290nm Laser Diode    20mW    Single mode /DFB			
Reverse Voltage	$V_r$	2.0	V
Operating Temperature	$T_{op}$	-10 ~ +50	°C
Storage Temperature	$T_{stg}$	-40 ~ +85	°C
Lead soldering temperature (10 sec.)	$T_{is}$	260	°C
<b>Features:</b> <ul style="list-style-type: none"> <li>• 1290nm</li> <li>• Single Mode Beam</li> <li>• DFB LD</li> <li>• With Flat Window</li> <li>• Built-in PD</li> </ul>			
<b>Applications:</b> <ul style="list-style-type: none"> <li>• Optical Fiber Communication</li> <li>• Free-space Optical Communication</li> </ul>			
<b>Specifications</b>	<b>RWLD-1290-020m-1-PD-F</b>		
	Min	Type	Max
Center Wavelength@25°C	$\pm 3\text{nm}$	1290nm	$\pm 10\text{nm}$
Output Power		20mW	
Spectral Width (FWHM)		0.3nm	1nm
Laser Type	DFB		
Recommend Operating Temperature	25°C		
Beam Divergence (FWHM)		$35^\circ_{\perp} \times 25^\circ_{//}$	
Reverse Current (PD) $I_{rp}$		0.5mA	
Reverse Voltage (PD) $V_{rp}$		----	15V
Threshold Current (Typ.)		5mA	15mA
Operating Current (Typ.)		90mA	100mA
Operating Voltage		1.4V	1.7V
Package Style		TO18	
Window Type	Flat Window		

**Package View:**

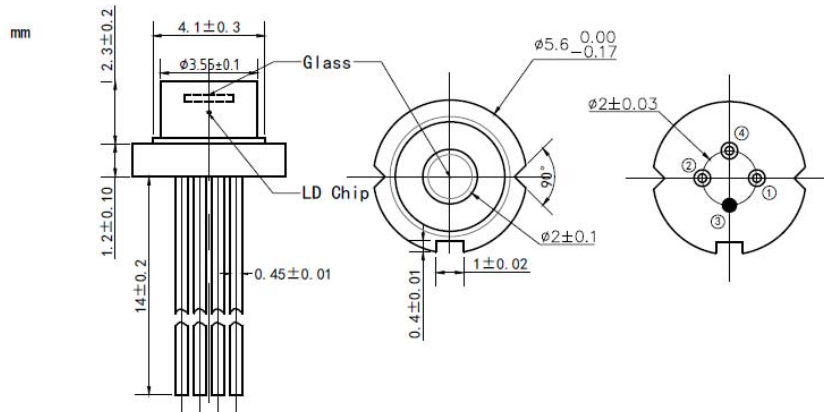

**PIN Bottom View (A-Type):**

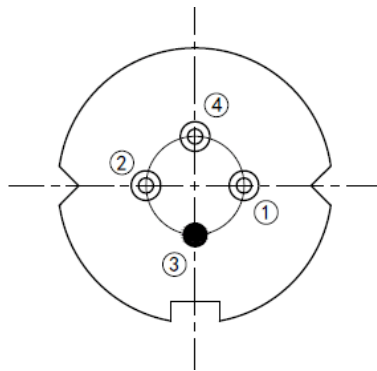

PIN 1	PD (+)
PIN 2	LD (-)
PIN 3	LD (+), CASE
PIN 4	PD (-)

**PIN Bottom View (B-Type):**

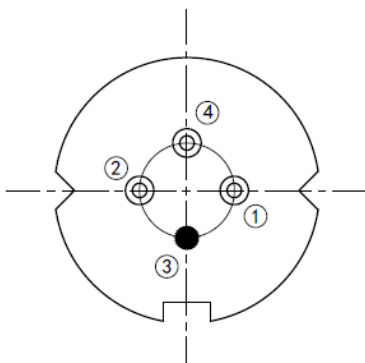

PIN 1	LD (+) PD (-)
PIN 2	LD (-)
PIN 3	CASE
PIN 4	PD (+)

Electrically shorten LD module and store in non-extreme conditions.

Suggest using the constant current power supply.

