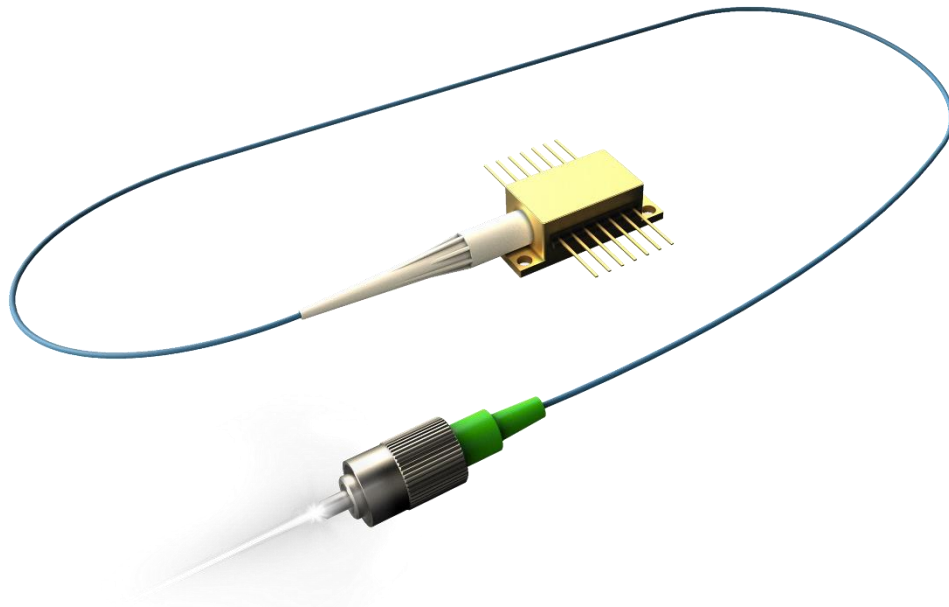


# DATASHEET

**1390nm SLED**  
**14-Pin Butterfly Package**

**Part# ASM002003**



## A. PRODUCT DESCRIPTION

This solution is a superluminescent diode (SLED) that comes in a 14-pin butterfly package, and operates within the near-infrared region (NIR). It is a compact package that provides an integrated optical interface and one of the highest power densities within the SLED technology industry.

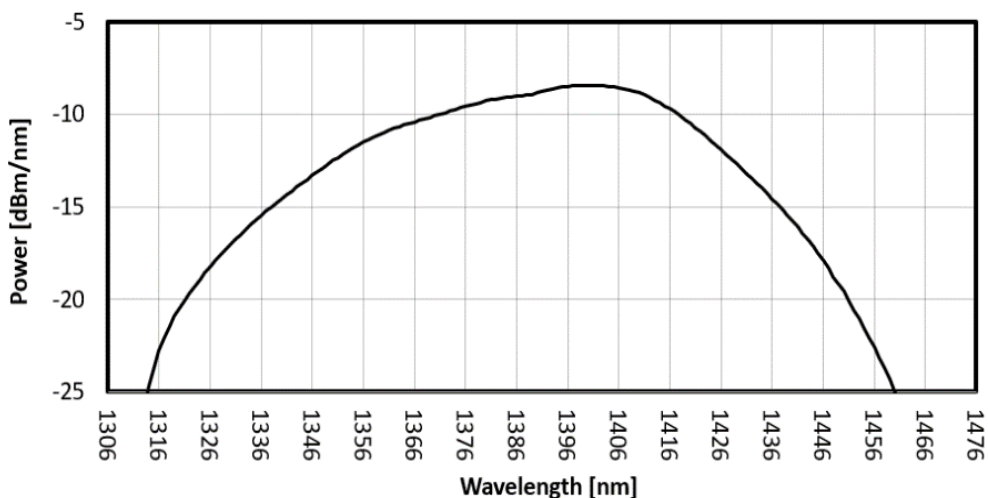
This package offers spectral coverage from 1360nm to 1420nm, with up to 10mW of optical power. The temperature of the device is regulated by an integrated thermoelectric cooler (TEC). This light source is robust and easy-to-use, making it an appropriate fit for many different types of manufactured assemblies requiring light power, including the applications below:

## B. KEY FEATURES

- SLED can be run from 0 – 100% of maximum rating
- Output power: >10mW
- Bandwidth FWHM: 60nm
- Light output: FC/APC Connector (Optional: FC/PC or SMA)
- SLED comes with a built-in independent monitor photodiode and one thermoelectric cooler (TEC)

## C. APPLICATIONS

- Optical Component Testing
- Telecom Test Equipment
- Medical Optical Coherence Tomography
- Industrial Optical Coherence Tomography
- Metrology
- Fiber Optic Gyroscopes
- Biomedical Imaging Systems
- Optical Sensing
- White Light Interferometry & Chromatic Dispersion
- Research and Development



#### D. ABSOLUTE MAXIMUM RATINGS (see note 1)

Parameter	Symbol	Condition	Min.	Max.	Unit
Reverse Voltage	$V_R$	CW	-	2	V
Operating Current	$I_{OP}$	CW $T_{OP} = 25^{\circ}\text{C}$ $T_{TEC} = 21^{\circ}\text{C}$	-	450	mA
Forward Voltage	$V_F$	CW $T_{OP} = 25^{\circ}\text{C}$ $T_{TEC} = 21^{\circ}\text{C}$	-	2.5	V
BTF Package Temperature (see note 2)	$T_{BTF}$	-	-40	80	$^{\circ}\text{C}$
SLED Operating Temperature	$T_{SLED}$	$I_{OP}$	0	70	$^{\circ}\text{C}$
TEC Current	$I_{TEC}$	-	-	2.6	A
TEC Voltage	$V_{TEC}$	-	-	3.56	V
TEC Temperature (see note 3)	$T_{TEC}$	-	0	50	$^{\circ}\text{C}$
Storage Temperature (see note 4)	$T_{stg}$	No condensation, Unbiased	-40	85	$^{\circ}\text{C}$
Storage Humidity (see note 4)	$RH_{stg}$	-	5	85	%RH
Electro Static Discharge (ESD)	$V_{ESD}$	Human Body Model	-	500	V
Lead Soldering Temperature	$T_{Solder}$	-	-	280	$^{\circ}\text{C}$
Lead Soldering Time	$t_{Solder}$	-	-	10	s

**Notes:**

1. Please note that exceeding the Absolute Maximum Ratings above may cause device failure. The manufacturer does not bear responsibility for laser power damage that is attributed to electrostatic discharge, excessive current levels, and current spikes (transients).  
  
Any attempts to increase the laser drive current above the pre-set limits or recommended specification limits, can damage the device, and nullify the warranty period. It should be emphasized that the current limit set points cannot be exceeded.
2. For optimum performance of the SLED, the SLED must be operated within the specified temperature ranges. The SLED has an internal thermoelectric cooler (TEC) but it's always required to mount the butterfly package on an appropriate heatsink, capable of dissipating up to 7W.
3.  $T_{TEC}$  is monitored by internal thermistor with external readout.
4. Storage temperature and relative humidity should be chosen so the dew point of the humid air around the package is below the storage temperature of the package, to avoid condensation on the package.

## E. OPTICAL AND ELECTRICAL SPECIFICATIONS (see note 5)

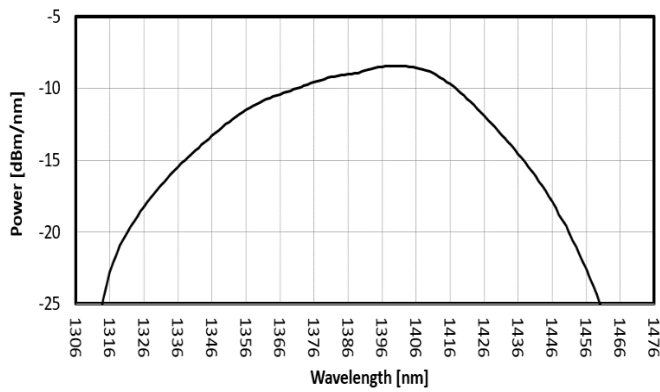
Parameter	Symbol	Condition	Min.	Typ.	Max.	Unit
Center Wavelength (see note 6)	CWL	CW T <sub>OP</sub> = 25°C T <sub>TEC</sub> = 21°C I <sub>OP</sub>	1380	1390	1400	nm
Operating Current	I <sub>OP</sub>	CW T <sub>OP</sub> = 25°C T <sub>TEC</sub> = 21°C I <sub>OP</sub>	-	-	400	mA
Forward Voltage	V <sub>F</sub>	CW T <sub>OP</sub> = 25°C T <sub>TEC</sub> = 21°C I <sub>OP</sub>	-	-	2	V
PM Fiber Coupled Power	P	CW T <sub>OP</sub> = 25°C T <sub>TEC</sub> = 21°C I <sub>OP</sub>	10	-	-	mW
Bandwidth FWHM (see note 7)	B <sub>FWHM</sub>	CW T <sub>OP</sub> = 25°C T <sub>TEC</sub> = 21°C I <sub>OP</sub>	60	65	-	nm
Bandwidth @-10dB	B@10dB	CW T <sub>OP</sub> = 25°C T <sub>TEC</sub> = 21°C I <sub>OP</sub>	-	120	-	nm
Spectral Coverage	SC	CW T <sub>OP</sub> = 25°C T <sub>TEC</sub> = 21°C I <sub>OP</sub>	-	1360 – 1420	-	nm
Spectrum Ripple (see note 8)	R	CW T <sub>OP</sub> = 25°C T <sub>TEC</sub> = 21°C I <sub>OP</sub>	<0.15	<0.30	<0.45	dB
Polarization Extinction Ratio (see note 9)	PER	CW T <sub>OP</sub> = 25°C T <sub>TEC</sub> = 21°C I <sub>OP</sub>	10	-	-	dB
Thermistor Resistance TEC	R <sub>THTEC</sub>	T <sub>OP</sub> = 25°C T <sub>TEC</sub> = 21°C	9.5	10.0	10.5	kΩ
Power Dissipation (see note 10)	P <sub>DISS</sub>	I <sub>OP</sub>	-	4	-	W
TEC Voltage	V <sub>TEC</sub>	-	-	-	2.8	V
TEC Current	I <sub>TEC</sub>	-	-	-	1.4	A

### Notes:

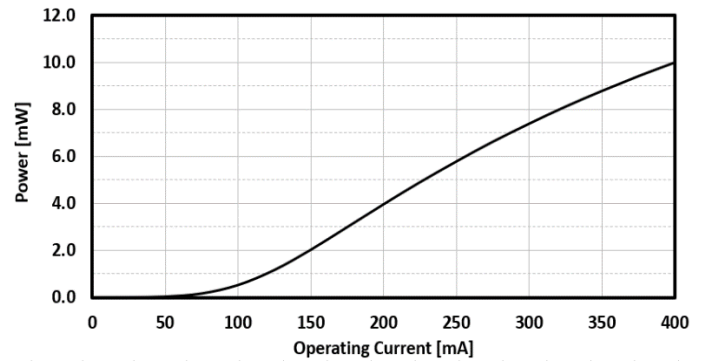
5. There may be differences in typical values of output power, power stability, wavelength and bandwidth, due to coupling efficiency. These values are references and there is no guarantee that each particular SLED module will have EXACTLY the typical values shown on the previous chart. The specification lists the operating temperature for the electrical/optical characteristics, which is the temperature of the SLED during the time that the specifications were measured. Variation in temperature beyond what is specified can have a significant effect on the optical characteristics, like changes in wavelength or drop in output power.
6. Center Wavelength is defined as the center point of the 3dB bandwidth of the SLED.
7. SLED FWHM is defined as the -3dB bandwidth from the center wavelength.
8. Resolution of 0.1nm.
9. Polarization Extinction Ratio is defined as the ratio of optical powers of perpendicular polarizations, expressed in decibels (dB).
10. Power dissipation when SLED is on and |T<sub>BTF</sub> - T<sub>TEC</sub>| is 40°C.

**F. PLOTS** – Test performed at  $T_{OP}=25^{\circ}C$  and  $T_{TEC}=21^{\circ}C$

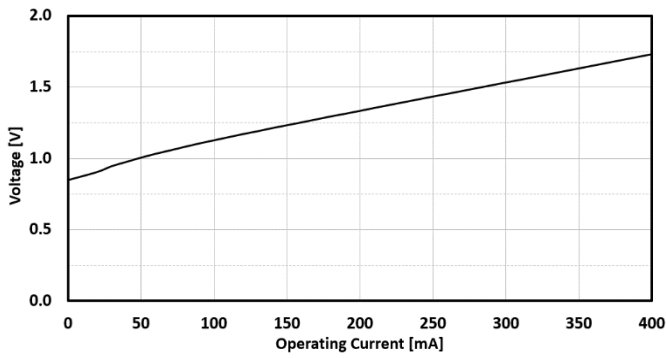
**FIG. 1: BTF PACKAGE SPECTRUM**



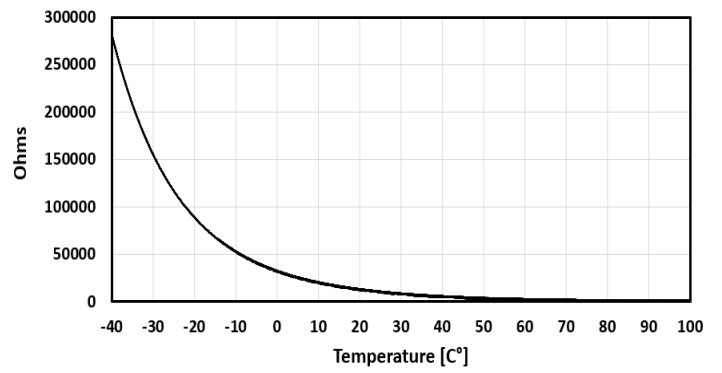
**FIG. 2: BTF PACKAGE OUTPUT POWER VS CURRENT**



**FIG. 3: BTF PACKAGE FORWARD VOLTAGE VS CURRENT**

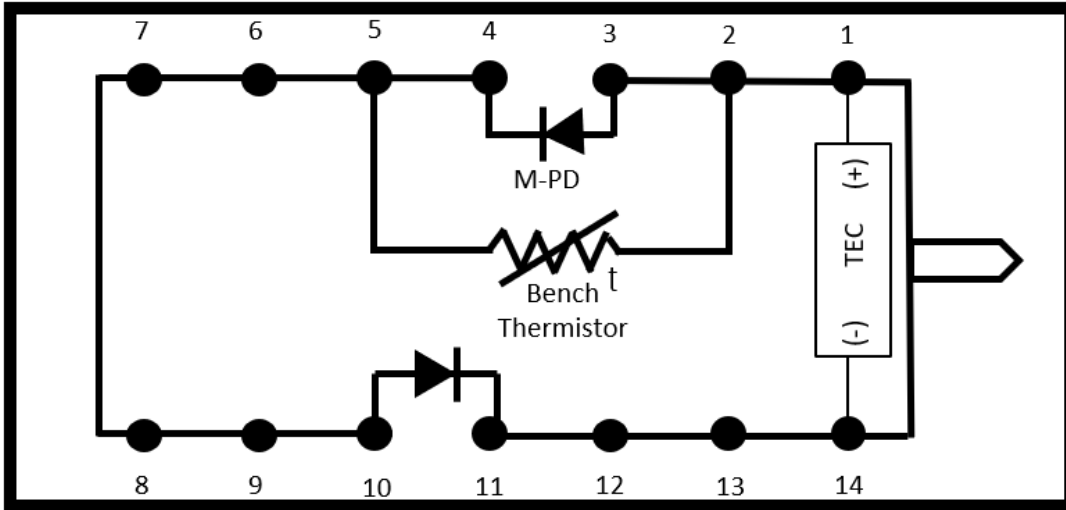


**FIG. 4: THERMISTOR  $R_{THTEC}$  RESISTANCE VS TEMP.**

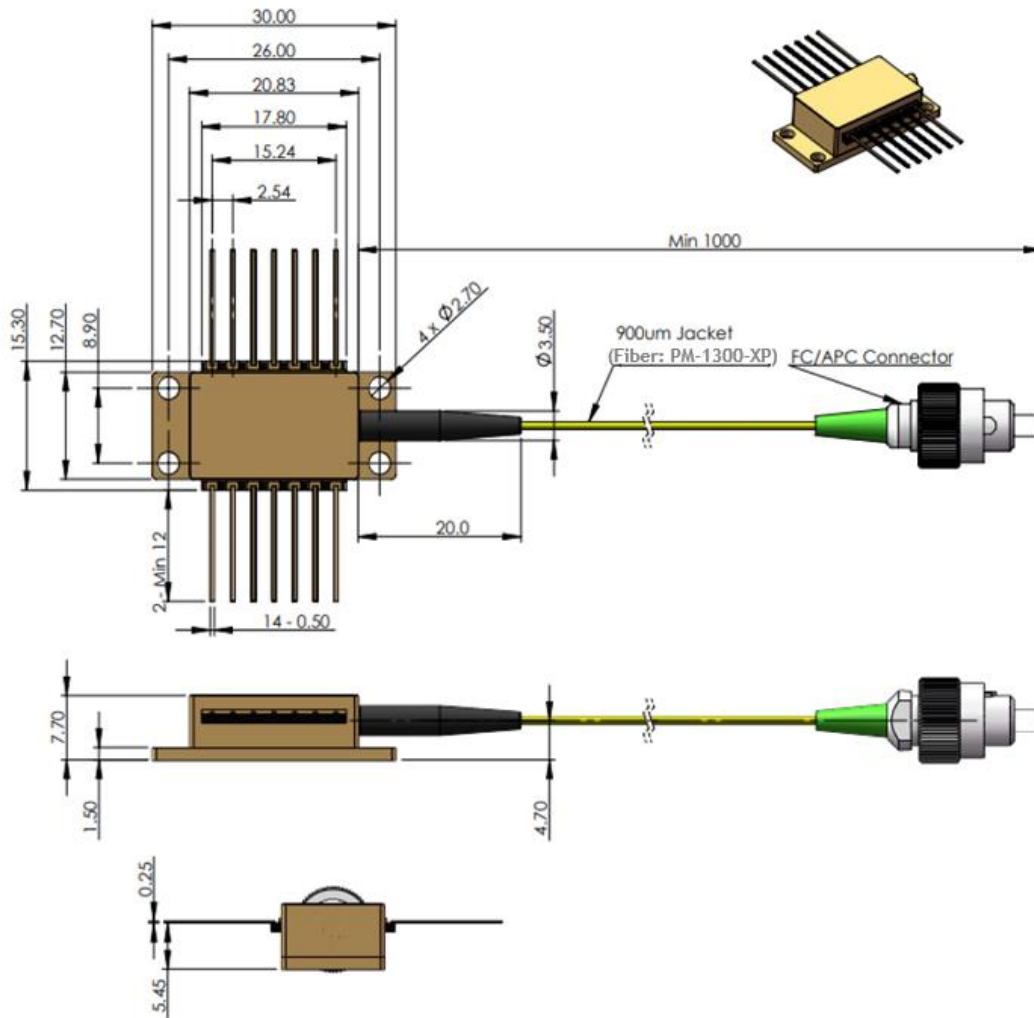


## G. PIN OUT

External Pin Assignment			
1	TEC +	8	NC
2	THERMISTOR	9	NC
3	M-PD ANODE (+)	10	SLEAD ANODE (+)
4	M-PD CATHODE (-)	11	SLED CATHODE (-)
5	THERMISTOR	12	NC
6	NC	13	CASE GND
7	NC	14	TEC -



## H. MECHANICAL DIAGRAM



Part	Description
Package type	14-pin Butterfly
Fiber:	PM-1300-XP
Core Diameter	8 $\mu$ m
Cladding Diameter	125 $\mu$ m
Coating Diameter	245 $\mu$ m
Jacket	900 $\mu$ m loose tube
Fiber pigtail length	1m
Fiber bending radius	>40mm
Connector	FC/APC
Dimensions	See figure

**I. MOUNTING RECOMMENDATIONS:**

The SLED can be mounted on a flat cooling surface without having to risk forming the pins. Mounting surface should be flat, with no physical obstructions underneath to cause any discontinuity in the surface flatness. If a heatsink is used, the base of the butterfly package will rest on the surface of a heatsink in order to cool the internal TEC.

Maximum torque to avoid damage to the device is 13 lb.in. /1.5 Nm. Minimum torque is 9 lb.in/1.1 nm. Do not use self-tapping screws. This light source should be mounted so that mechanical vibrations cannot cause short circuits between leads. AZIMUTH 7 pin, 0.100" pitch Sockets are recommended. The 14 pins will rest on a pair of spring-loaded sockets and be squeezed between the contacts and a plastic clamp.

**J. SAFETY**

All statements regarding safety of operation and technical data will only apply when the unit is operated correctly.

This SLED is a Class 1M laser product. It is safe for all conditions of use except when passed through magnifying optics such as microscopes and telescopes. It produces a beam that is divergent. If light is re-focused use protective eye wear.

**K. ORDERING CODE**

ORDERING CODE:		BTF	SLEDs	FT	DOP	SC	FWHM	CW	LOP
BTF	14-Pin Butterfly Package SLED								
SLEDs	SLED center wavelength, choose one of the following models: 1300nm, 1340nm, 1390nm, 1430nm, 1480nm, 1550nm, 1615nm, 1680nm								
FT	Fiber Type, choose 1: PM: Polarization Maintaining SM: Single Mode								
DOP	Degree of Polarization HP: High Degree of Polarization								
SC	Spectral Coverage [nm]								
FWHM	Full Width Half Maximum [nm] [FWHM defined as the bandwidth from the lowest spectral dip]								
CW	Center Wavelength [nm]								
LOP	Light Output Power [mW]								

<span style="display:inline-block; width:10px; height:10px; background-color: #4F81BD; border: 1px solid black;"></span> Product Code
<span style="display:inline-block; width:10px; height:10px; background-color: #D9E1F2; border: 1px solid black;"></span> Available Options
<span style="display:inline-block; width:10px; height:10px; background-color: #E6E6E6; border: 1px solid black;"></span> Taken From Table



Part Number	Ordering Code: LTC-05E1-(SLED)-(FT)-(DOP)-(SC)-(FWHM)-(CW)-(LOP)	SLED [nm]	FT	SC [nm]	FWHM [nm]	CW [nm]	LOP [mW]
ASM002001	BTF-1300-PM-HP-1270_1330-60-1300-12	1300	PM	1270-1330	60	1300	12
ASM002002	BTF-1340-PM-HP-1310_1370-60-1340-12	1340	PM	1310-1370	60	1340	12
ASM002003	BTF-1390-PM-HP-1360_1420-60-1390-10	1390	PM	1360-1420	60	1390	10
ASM002004	BTF-1430-PM-HP-1410_1450-40-1430-10	1430	PM	1410-1450	40	1430	10
ASM002005	BTF-1480-PM-HP-1455_1505-50-1480-13	1480	PM	1455-1505	50	1480	13
ASM002006	BTF-1550-PM-HP-1515_1585-70-1550-15	1550	PM	1515-1585	70	1550	15
ASM002007	BTF-1615-PM-HP-1585_1645-60-1615-6	1615	PM	1585-1645	60	1615	6
ASM002008	BTF-1680-PM-HP-1655_1705-50-1680-13	1680	PM	1655-1705	50	1680	13
ASM002009	BTF-1550-PM-HP-1500_1600-70-1550-8	1550	PM	1500-1600	70	1550	8
ASM002012	BTF-1550-PM-HP-1532_1568-35-1550-30	1550	PM	1532-1568	35	1550	30

Part Number	Ordering Code: LTC-05E1-(SLED)-(FT)-(DOP)-(SC)-(FWHM)-(CW)-(LOP)	SLED [nm]	FT	SC [nm]	FWHM [nm]	CW [nm]	LOP [mW]
ASM002101	BTF-1300-SM-HP-1270_1330-60-1300-12	1300	SM	1270-1330	60	1300	12
ASM002102	BTF-1340-SM-HP-1310_1370-60-1340-12	1340	SM	1310-1370	60	1340	12
ASM002103	BTF-1390-SM-HP-1360_1420-60-1390-10	1390	SM	1360-1420	60	1390	10
ASM002104	BTF-1430-SM-HP-1410_1450-40-1430-10	1430	SM	1410-1450	40	1430	10
ASM002105	BTF-1480-SM-HP-1455_1505-50-1480-13	1480	SM	1455-1505	50	1480	13
ASM002106	BTF-1550-SM-HP-1515_1585-70-1550-15	1550	SM	1515-1585	70	1550	15
ASM002107	BTF-1615-SM-HP-1585_1645-60-1615-6	1615	SM	1585-1645	60	1615	6
ASM002108	BTF-1680-SM-HP-1655_1705-50-1680-13	1680	SM	1655-1705	50	1680	13
ASM002109	BTF-1550-SM-HP-1500_1600-70-1550-8	1550	SM	1500-1600	70	1550	8
ASM002112	BTF-1550-SM-HP-1532_1568-35-1550-30	1550	SM	1532-1568	35	1550	30