

POWERMIR

by mirSense

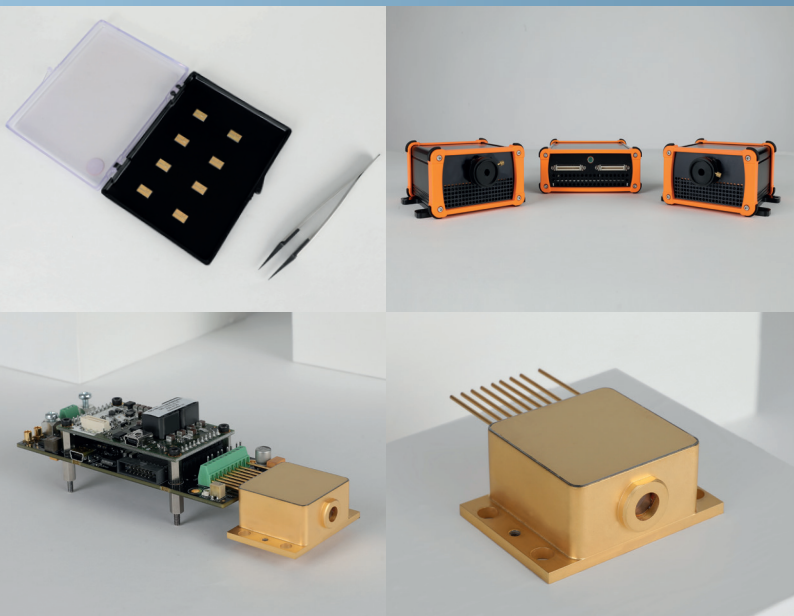

From left to right, top to down : Chips, turnkey system, QCL + electronics, HHL-package

ITAR free MIR high-power quantum cascade laser systems

The PowerMir product line is high power pulsed Fabry Perot Quantum Cascade Lasers (QCL) based on high-performance proprietary technology and the lasers described in this datasheet emit around 4 microns of wavelength.

Proudly manufactured in France, mirSense lasers are ITAR free and have outstanding power and wall-plug efficiency performances. Customers can purchase different laser system configurations like plug-and-play benchtop turnkey systems, OEM driver + laser modules or just the HHL-packaged lasers.

Benefits:

- ITAR free technology
- QCW operating mode for increased wall-plug efficiency and reduced thermal dissipation
- Reproducible specs manufacturing for series productions
- Circular beam (option) to reduce efforts made by clients to shape the beam

Features

Maximum power ¹	>1W or < 500mW ² or < 100mW ²
Mode of operation	Quasi-CW, high duty cycled pulsed
Central wavelength ⁽³⁾	4 μm +/- 0.1 μm
Pulse frequency	> 500 kHz
Divergence for the lasers with standard beam ⁴	3 to 6 mrad (horizontal) 2 to 4 mrad (vertical)

1. The maximum power is the maximum average optical power available in the spectrum band 3.85 microns to 4.15 microns.

2. The power is given when the base plate temperature of the HHL-package is regulated at +20°C. < 500mW means that the maximum average power will be between 450mW and 500mW. Under 500mW, the laser is not considered a dual use product and therefore no export control applies. The laser's specified output power is the sum over the full spectral bandwidth. < 100mW means that the maximum average power will be roughly between 90mW and 100mW.

3. The central wavelength is defined as the optical power weighted average of the wavelength.

4. The divergence is given at full angle. The shape of the beam is slightly elliptical

Divergence for the lasers with circular beam option ¹	2,5 mrad ¹
Beam quality	TM00 Gaussian beam, $M^2 < 1.5$
Output beam dimension for the standard beam option (window output)	Typically 3 mm (vertical) x 2 mm (horizontal)
Output beam dimension for the circular beam option (window output)	Typically < 3mm
Polarization	Linear vertically polarized (>98%)
Reliability	> 3500 h

1. The divergence is given at full angle. The shape of the beam is circular

Typical Beam quality

The picture shows the 2D mapping of the laser far field taken in intensity scale.

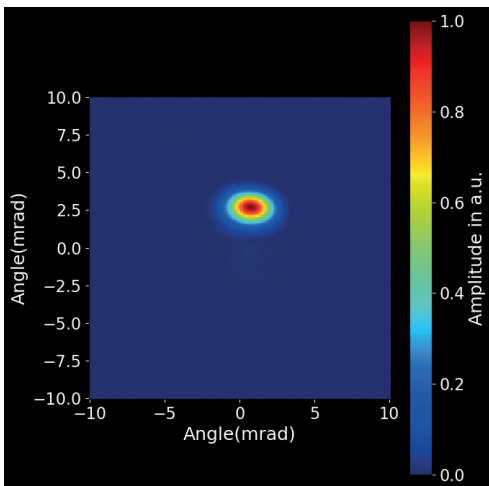

Standard laser beam

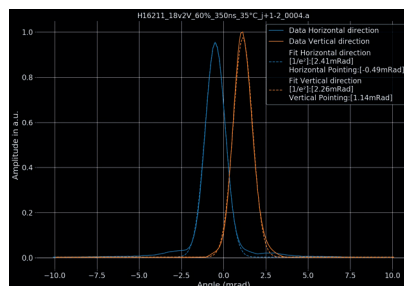

Laser with circular beam option

The circular beam that mirSense clients get is much more robust than if an external optical component were used to make the beam circular because the circular beam option means that mirSense manufactures a special chip that emits a circular beam before the lens, ie the circularity is reached at chip-level so it's a very robust feature.

Average optical power

Average optical power of the laser as a function of the laser duty cycle with a pulsewidth of 300ns and a laser temperature of +20 °C

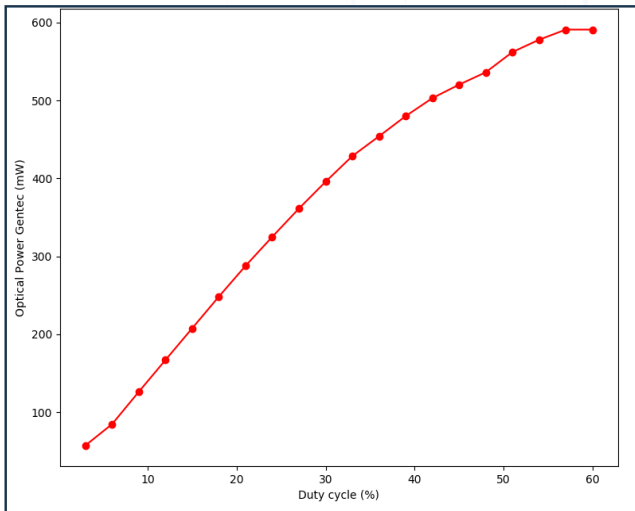

500mW laser

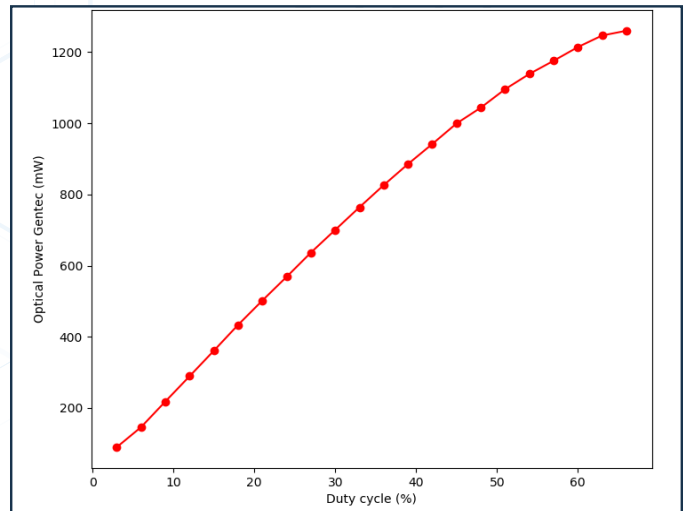

> 1W laser

Typical spectrum

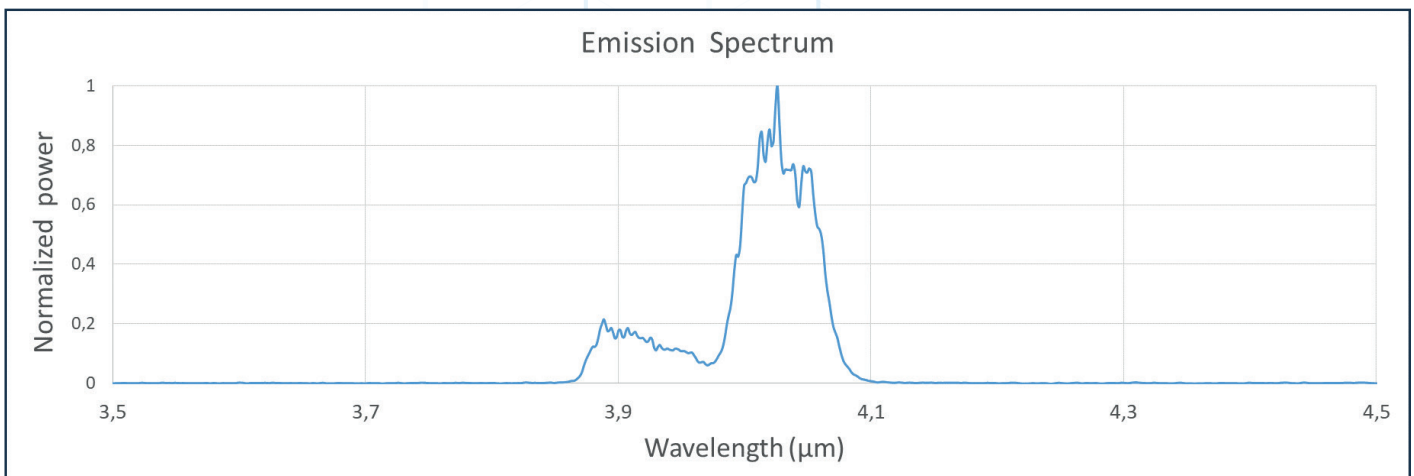

4 μ m

SYSTEM CONFIGURATIONS

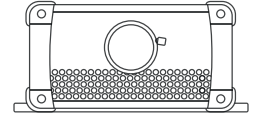

Customers can purchase different laser systems depending on their needs

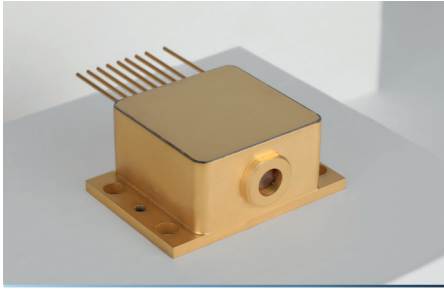

For customers who want to purchase just the laser, mirSense provides HHL-packaged lasers with a built-in TEC and thermistor to control the chip temperature and a collimating lens inside the package. These lasers are burned-in during the manufacturing process to guarantee power and wavelength stability over time and the packages are hermetically sealed with dry N2 air inside.

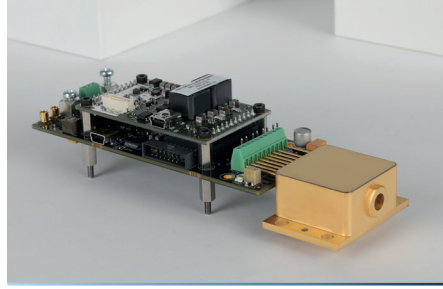

For clients who want to integrate the laser in a product, mirSense provides an OEM module controllable by Modbus or Windows Software and made of a PCB driver connected to a HHL-packaged laser. The driver takes care of temperature and current control, laser safety and modulation is possible, both external with a TTL signal or with a Windows software.



For lab development purposes, mirSense provides a **plug-and-play benchtop turnkey system** that takes care of everything like temperature and current control, air cooling and laser safety and comes with a user friendly Windows software to operate the laser and modulate its power (external TTL modulation being also possible). The turnkey system can control two laser heads at the same time and can be fitted with red beam alignment lasers to help find the infrared spot in the far field.

	HHL package	OEM module	Turnkey system
Collimating lens inside the package	✓	✓	✓
Built-in thermistor and thermoelectric cooler (TEC) inside the package	✓	✓	✓
Sealed atmosphere package	✓	✓	✓
OEM integration	✓	✓	
Plug and play			✓
Multiple laser heads			✓
Red beam alignment			✓
Air cooling			✓
Manual shutter & safety key			✓
User friendly software		✓	✓
Temperature control of QCL chip		✓	✓
MODBUS control		✓	
Software or TTL power modulation		✓	✓
Down to 10ns of electrical pulsewidth		✓	✓
252-points modulation envelope that the user can customize			✓



The plug-and-play benchtop turnkey system

The turnkey system is an air-cooled plug-and-play benchtop system that customers can use for lab development purposes.

A user friendly Windows software controls both the temperature and the current, thus preventing laser damage. The power is easily modulated by software or external TTL signal.

For different projects, the same driver can be connected to one or two laser heads, regardless of wavelength or power.

Benefits:

- Supports high-power lasers and can operate lasers >1W of power
- Fast: can modulate down to 10 nanoseconds of pulsewidth
- Can operate QCW lasers
- Plug-and-play system that takes care of everything (air cooling, driver, temperature management..)
- Keep your driver for future extra laser heads – no need to purchase a new driver
- Red beam laser helps you find the IR beam in the far distance

Features

On the right is pictured a thermal card that shows the red beam and the IR beam superimposed at 14m distance. The red beam is a convenient option to find the IR beam in the far distance.

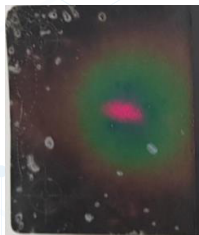

Functionalities	Laser safety, Laser driver (ON/OFF), Laser temperature and TEC control, frequency modulation, duty cycle, external TTL
Physical interface	USB interface for PC connexion (USB cable supplied) TTL trig IN connector for TTL external signal TTL trig OUT connector for synchronisation Option: Extra red laser beam (class 3R) (typically <3mrad of pointing difference between the red laser beam and the infra-red beam) to find the IR beam is in the farfield.
Software	A user friendly Windows software is supplied
Input power	24V DC (an AC/DC power transformer is supplied)
Dimension	laser head: 20cm x 15cm x 6cm / driver: 25cm*15cm*6cm
Weight	925 g
Operational temperature	+10°C to +30°C of ambient temperature
Laser head cooling	Air cooled

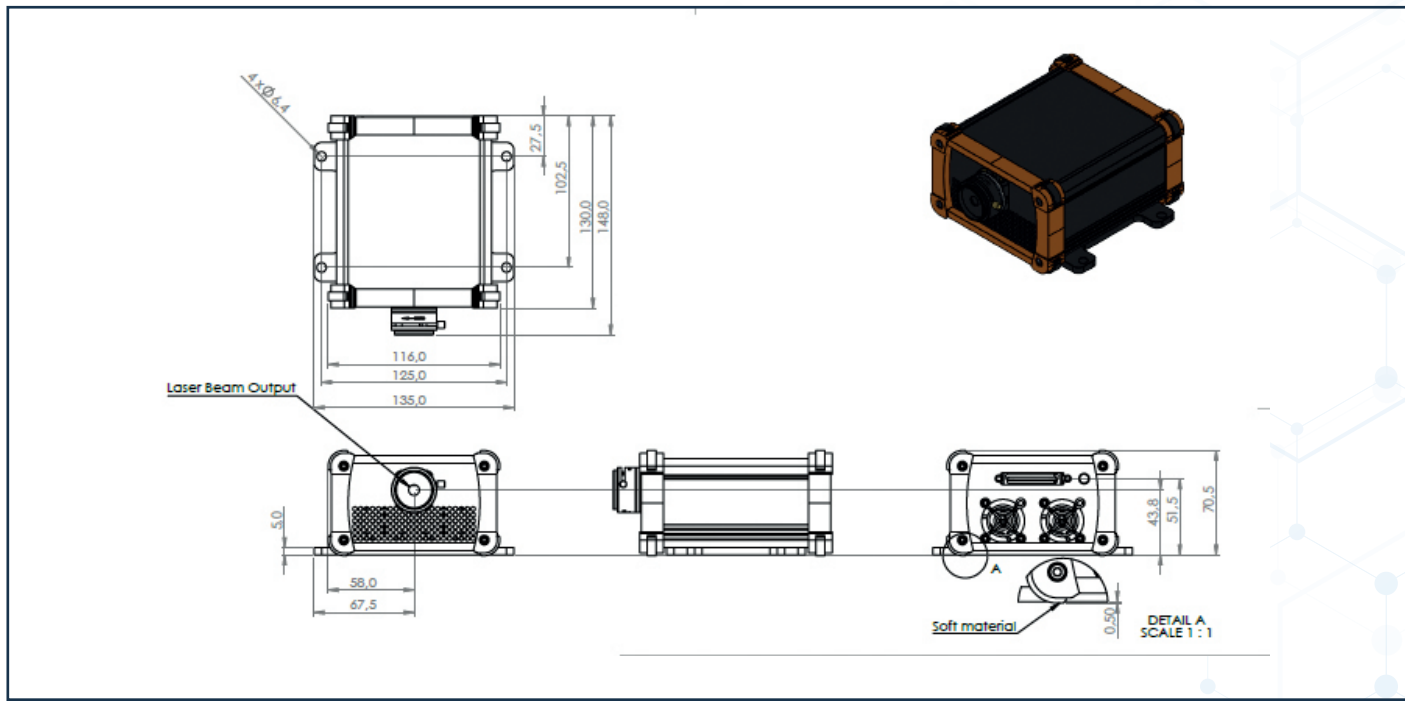

Laser head drawing

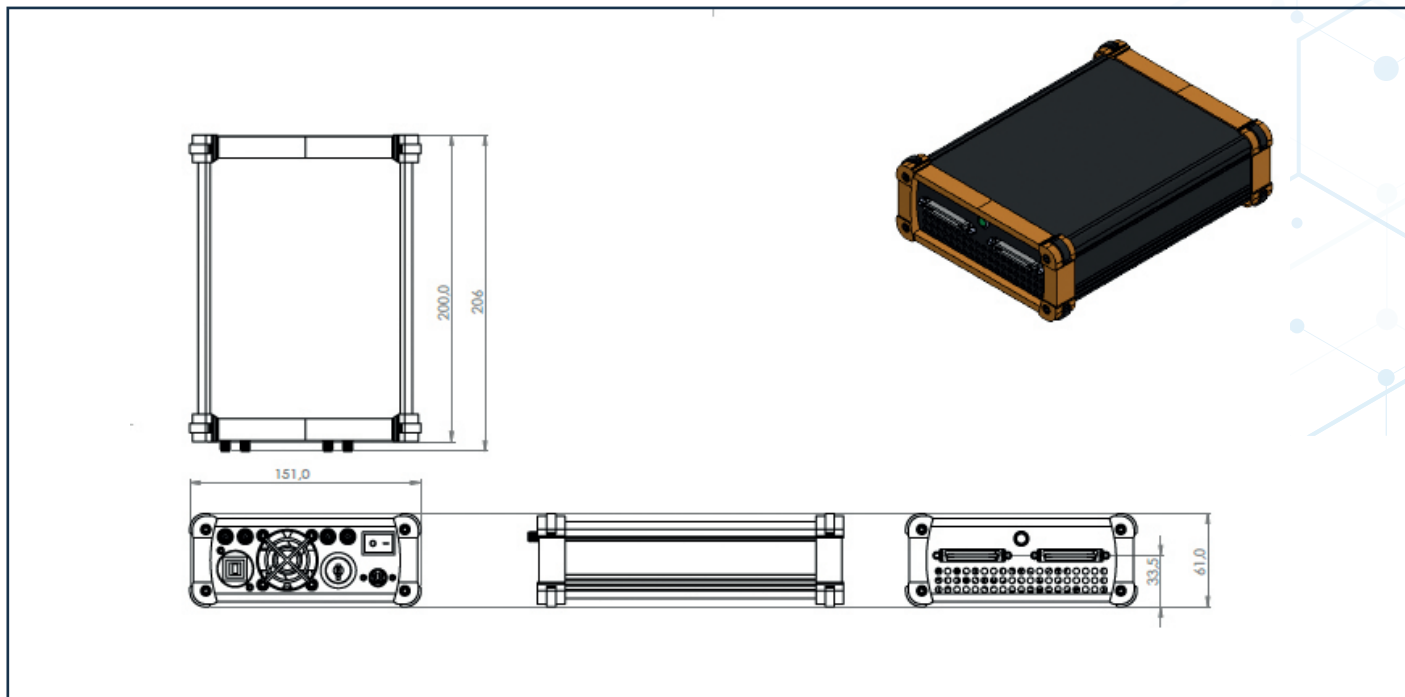

Driver drawing



Software screenshot example

◀ The PC software allows the user to easily select 3 different power levels over which the user can modulate either by using the software with a 252-points modulation envelope or with an external TTL signal. The software has built-in safety features that safeguard the laser (for example, temperature management)



Connectors and cables are provided



You might want to read the following documents that were written to help our customers better control their turnkey systems, please ask your mirSense representative to send you the latest pdf versions.

- ✓ PowerMir Application note - Describes how you can modulate the power
- ✓ Turnkey system Software user guide - Describes how you can control the system with the supplied Windows Software
- ✓ Communication protocol - Describes how you can control the system with Modbus communication over RS485
- ✓ Turnkey system General User guide - Describes how to generally operate the system

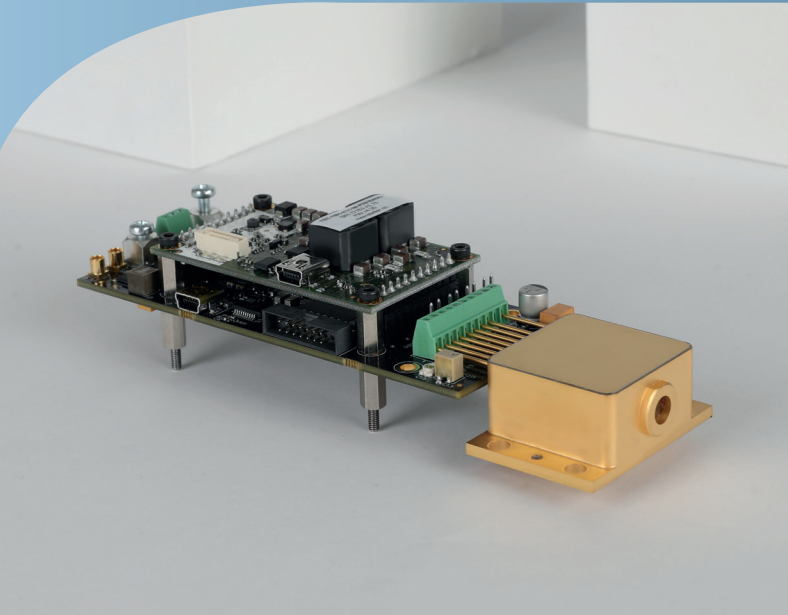

POEM series : HHL-packaged laser + driver OEM modules

This system is made up of a QCL HHL-packaged laser plugged to an OEM PCB driver board. Onboard firmware and Windows software are both provided.

Benefits:

- Generates pulsewidths down to 10ns
- Both external (TTL) and internal modulation with Windows software possible
- Driver includes both temperature and current control and onboard firmware safeguards the laser
- Controllable both with user friendly Windows software supplied or with Modbus communications over RS485
- Several systems can be controlled and synchronized for power combination
- Designed for OEM integration into systems

Features

Functionalities	Laser safety, Laser driver (ON/OFF), Laser temperature and TEC control, frequency modulation, external TTL
Physical interface	USB, RS485
Protocol	MODBUS
Input power	24V DC
Dimension	4.45cm x 11cm x 2.5cm
Weight	190 g (HHL 120g and PCB 70g)
Operational temp.	-20 °C to +30 °C @ base plate. This working environmental temperature must in any case be above dew point to avoid water condensation

Software and communications

Each system can be controlled by MODBUS over RS485 and several systems can be controlled by one single supervisory computer. Furthermore, a user-friendly Windows software is supplied to allow customers to easily control one or several systems. See software user guide for more details.



Screenshot of the user-friendly Windows software

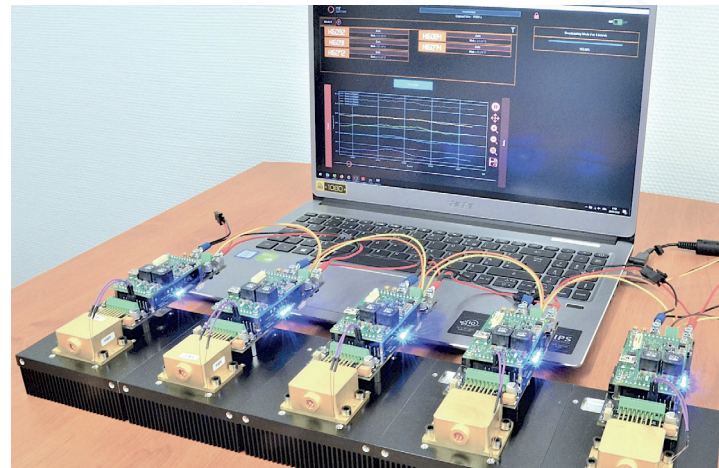

One single PC can control several systems



You might want to read the following documents that were written to help our customers better control their OEM driver+laser modules, please ask your mirSense representative to send you the latest pdf versions.

- ✓ PowerMir Application note - Describes how to modulate the power
- ✓ OEM driver+laser Software user guide - Describes how to control the system with Windows Software
- ✓ OEM driver+laser Communication protocol - Describes how to control the system with Modbus communication
- ✓ OEM driver+laser Interface Control documentation - Describes the interface of the system
- ✓ OEM driver+laser General User guide - Describes how to generally operate the system
- ✓ 3D .step files

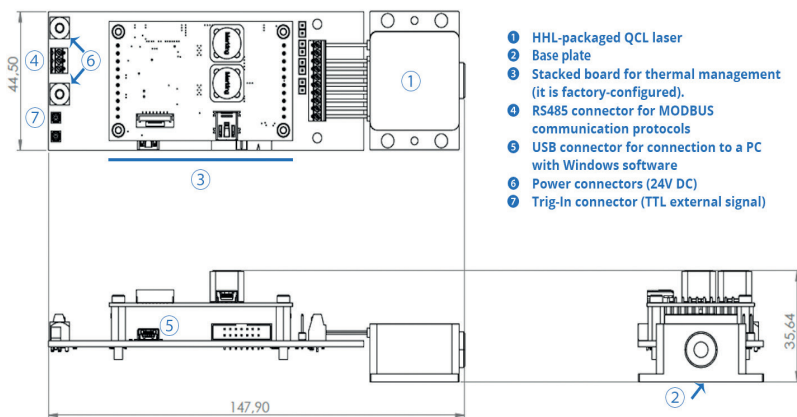

Drawings (dimensions in mm)

Do not use hands to touch the window surface, wear gloves as your digital fingerprints can stay on the window of the HHL-laser.

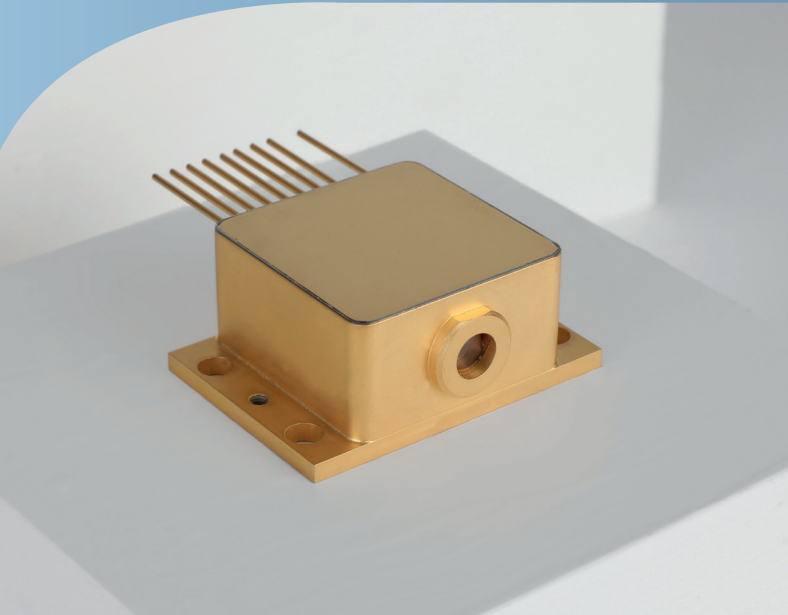

HHL-packaged lasers

The High Heat Load (HHL) package includes the high power laser mounted on a thermoelectric cooler and suitable optics to collimate the beam of the laser.

Benefits:

- Built-in TEC and thermistor for temperature control of the chip
- Built-in collimated lens
- Robust packaging for harsh environments

Features

Packaging	Hermetically sealed with nitrogen gas fill inside a High-Heat Load (HHL) package
Wall-plug efficiency	5 to 10%
Built-in TEC included	$I_{max} = 5.2A$, $V_{max} = 15.7V$
Built-in temperature sensor thermistor	Resistance @ 25°C: 10 kΩ 0/50 °C Beta value: $\beta = 3892 K$
Laser current (typ.)	2 A
Laser voltage	10 to 20 V
Operational temperature	-20 °C to +30 °C @ base plate. This working environmental temperature must in any case be above dew point to avoid water condensation
Weight	120 grams

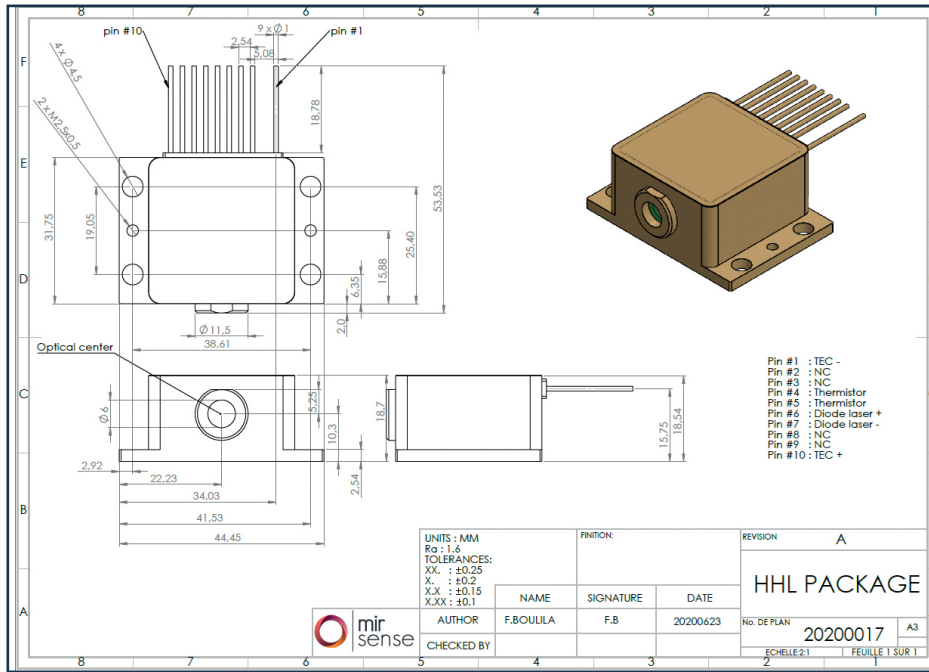

Drawing - All dimensions are in mm

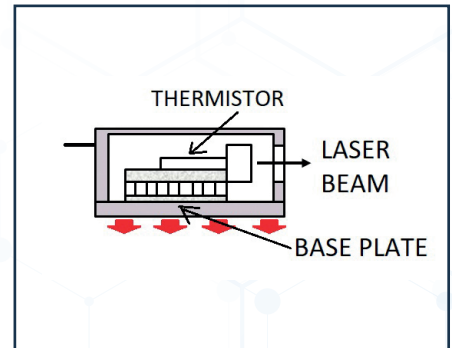

The above HHL-package diagram shows the built-in thermistor that indicates the laser chip temperature. The diagram also shows the base plate that dissipates the heat (because typically the built-in TEC will cool down the laser chip).

Electrical connections (pinout)

1	TEC (-)
2	no pin
3	Not connected
4	Thermistor (10kΩ)
5	Thermistor (10kΩ)

6	QCL (+)
7	QCL (-)
8	Not connected
9	Not connected
10	TEC (+)

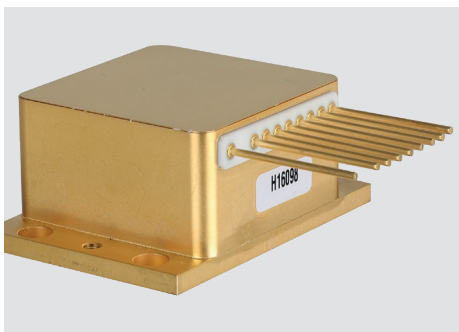

Rear view with its serial number

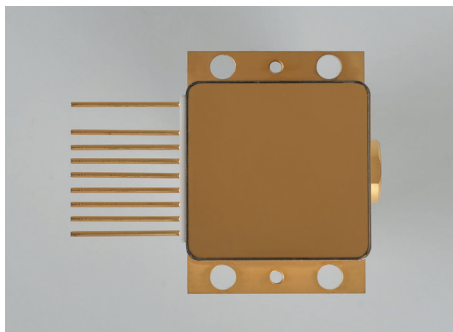

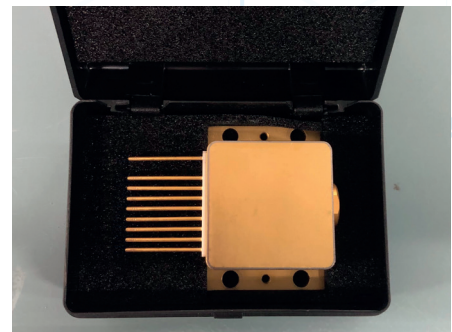

Seen from above

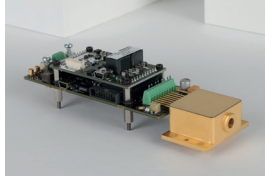

In its shipping case

If you need, your mirSense representative can send you the 3D step file of the HHL-packaged laser. Do not solder the pins of the HHL; you may use crimp housing from the Molex brand (ref 22-01-3107) and crimp terminal (Molex ref 08-50-0032) to connect your laser. Do not use hands to touch the window surface, wear gloves as your digital fingerprints can stay on the window of the HHL-laser.

	HHL-packaged laser	OEM PCB driver +laser (POEM series)	Plug-and-play benchtop turnkey system
			
<100mW @ 4μm standard beam	PW4000090HSNA	PW4000090HSPCB	PW4000090HSTK1A
>450mW @ 4μm standard beam	PW4000450HSNA	PW4000450HSPCB	PW4000450HSTK1A
>1W @ 4μm standard beam	PW4001000HSNA	PW4001000HSPCB	PW4001000HSTK1A
<100mW @ 4μm circular beam	PW4000090HCNA	PW4000090HSPCB	PW4000090HSTK1A
>450mW @ 4μm circular beam	PW4000450HCNA	PW4000450HSPCB	PW4000450HSTK1A
>1W @ 4μm circular beam	PW4001000HCNA	PW4001000HSPCB	PW4001000HSTK1A

Optical power level	Safety class of the laser system
> 500mW	Class 4
Between 50mW and 500mW	Class 3B
Between 10mW and 50mW	Class 3R
< 10mW	Class 1

What is the safety class of my laser ?

Laser systems have safety classes to assess the risk for humans (like eye burning). The safety class is applicable for the global laser system, not to the individual diode because the safety class depends on how the laser diode is used. This is why mirSense doesn't give a laser safety class for its HHL-packaged lasers but only for its OEM and turnkey systems.

The laser safety class of a pulsed-laser system depends on the average optical output power.